



# NS-AP3400

## HOME CINEMA SPEAKER PACKAGE

*Main, Center and Surround Speakers*

### The Yamaha Commitment:

Audio and visual media, when skillfully integrated, have an enormous potential to excite us, to touch our innermost feelings, and to broadly stimulate our imaginations. Yamaha's unvarying commitment is to create A/V components that make the entertainment experience more dynamic and meaningful, to not only give you pleasure, but to expand and enrich your life.

Out of the hundreds of loudspeaker manufactures, Yamaha is the only one that also makes musical instruments. YAMAHA audio components and speakers can be found in the homes and recording studios of audiophiles and industry professionals alike. No other company is as intimately involved with the production and reproduction of fine music.

### KEY FEATURES OF THE NS-AP3400 SPEAKER PACKAGE ARE:

- A/V magnetically shielded.
- Developed to give high performance on all channels.
- 2 way acoustic suspension design.
- Ideal for Dolby DIGITAL™ or DTS™ surround systems and other high quality home theater applications.
- Utilized as a main speaker, center channel speaker, and surround speaker.
- Fully voice – matched system.
- Can be used on shelf, stand or wall mounted.

## Owner's Manual

### CONTENTS

Consumer Precautions .....	1
Connections to the Amplifier or Receiver .....	1
Using with Yamaha Active Servo Processing Subwoofers .....	1
Setting up the Speakers .....	2
Speaker Placement .....	2
Specifications .....	2

### IMPORTANT:

Please record the serial number of your loudspeakers in the space below.

Model: NS-AP3400                      Serial No. \_\_\_\_\_

The serial number is located on the rear of each unit.

Retain this Owner's Manual in a safe place for future reference.

## CONSUMER PRECAUTIONS

Read these precautions carefully before operating your NS-AP3400 speakers.

Since these speakers can be wall mounted, it is essential that they are firmly secured.

Be sure to consult a reliable source about the best type of hanger for your particular wall's construction. Secure installation is the purchaser's responsibility.

Do not attach them to thin plywood or soft wall surface materials as the screws may tear free, causing the speakers to fall and be damaged, or result in personal injury.

Do not fasten the speakers to walls with nails, adhesives, or other unsafe hardware.

Long-term use and vibrations may cause them to pull free.

Do not place the speakers where they are liable to be knocked over or struck by falling objects. Stable placement will also ensure better sound performance.

Placing the speakers on the same stand or shelf as a turntable can result in feedback.

This speaker features a magnetically shielded design, but there is still a chance that placing it too close to a TV set might impair picture color. Should this happen, move the speaker away from the TV set.

Never touch the woofer or tweeter units with your hands or expose them to excessive physical shock. If they are dented or bent, the sound will be distorted.

Lower the power amplifier/receiver volume control before changing input sources. Never change input sources (for example, FM to CD) at high listening levels. Always turn the receiver / amplifier unit off when installing or removing input cables.

Anytime you note distortion, reduce the volume control on your power amplifier / receiver to a lower setting. Never allow your power amplifier to be driven into "clipping".

Do not attempt to clean the speakers with chemical solvents as this might damage the finish. To clean wipe with a dry, soft cloth.

To prevent the enclosure from warping or discoloring, do not place the speakers where they will be exposed to direct sunlight or excessive humidity.

## USING WITH YAMAHA ACTIVE SERVO PROCESSING SUBWOOFERS

This YAMAHA speaker is designed to give excellent balanced sound performance on all channels of a Dolby DIGITAL™ or DTS™ surround system. Since surround systems often contain a lot of very low frequency sounds, we suggest using these speakers in conjunction with one or more powered subwoofers to get the maximum performance from your sound system.

Please refer to your subwoofer owner's manual for proper connection instructions.

## CONNECTIONS TO THE AMPLIFIER OR RECEIVER

To assure low distortion on program peaks, your amplifier or receiver should be capable of delivering at least 10 watts RMS (continuous sine-wave power) per channel. This speaker can be used safely with amplifiers rated at up to 30 watts RMS per channel.

Amplifiers rated at higher than 30 watts RMS (continuous sine-wave power) per channel must be used with care.

### CONNECTIONS

Check to make sure that the power has been turned off before making connections.

Connect the (+) terminal of the amplifier to the (+) terminal of the Speaker.

Connect the (-) terminal of the amplifier to the (-) terminal of the Speaker.

Reversing polarity (+/-) will result in unnatural sound reproduction.

### PROCEDURE

For connections, keep the speaker cords as short as possible. Do not bundle or roll up the excess part of the cords. If the connections are faulty, no sound will be heard from the speakers. Make sure that the + and - polarity markings of the speaker cords are observed and set correctly. If these cords are reversed, the sound will be unnatural and lack bass.

#### Main/center/rear speakers

One side of the provided speaker cord has white line and the other side has no line.

Connect the (+) terminals on both the speaker and the amplifier using the side with a white line.

Connect the (-) terminals on both components using the side with no line.

#### How to Connect:

Press and hold the terminal's tab, as shown the figure.

Insert the bare wire end properly in to the terminal hole.

[Remove approx. 10mm(3/8") insulation from the speaker cord.]

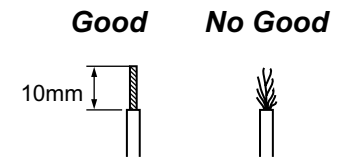
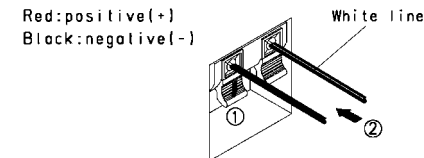

Release your finger from the tab to allow it to lock securely on the cord's wire end.

Test the firmness of the connection by pulling lightly on the cord at the terminal.

### Notes

Do not let the bare speaker wires touch each other as this could damage the speaker or the amplifier, or both of them.

## SETTING UP THE SPEAKERS

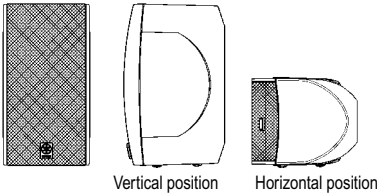

Main and rear speakers can be positioned horizontally or vertically. Please install rubber feet included to prevent slipping movement. Please note: Logo can rotate.

### Mounting the center speaker

Place the center speaker on top of the TV, on the floor under the TV or inside the TV rack so that it is stable.

When placing the speaker on top of the TV, inside of the Rack or top of the TV Stand horizontally or vertically, put the provided Velcro strips at two points on both the bottom of the speaker and top of the TV, mounting surface on the Rack or top of the TV Stand to prevent the speaker from falling.

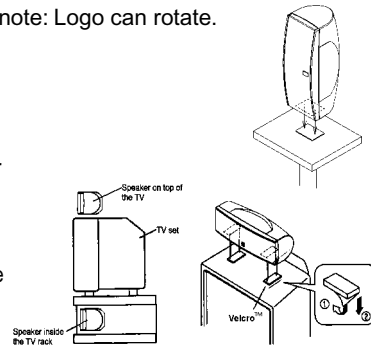

### Notes

Do not place the speaker on top of the TV whose area is smaller than the bottom area of the speaker. The speaker may fall and might cause personal injury.

Though this speaker is a magnetically shielded type, there may be some influence on a TV picture depending on the type of TV or the placement of the speaker. In such a case, place the speaker apart from TV so that there is no influence on TV picture.

### Mounting the main and rear speaker

Please place rubber feet as shown in the diagram prior to mounting the speakers on the wall.

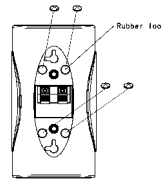
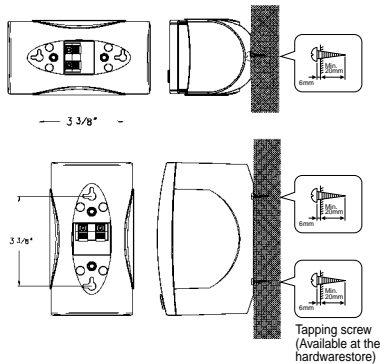

Fasten screws into a film wall or wall support as shown in the figure, and hang the holes of the mounting bracket on the protruding screws. Make sure that the screws are securely caught by the narrow sections of the "key hole" opening. Main and rear speakers can be mounted horizontally or vertically.

### WARNING

Each speaker weight 1.76 lbs (0.80kg). Do not mount them on thin plywood or soft surface material. If mounted, the screw may come out of the flimsy surface and the speakers may fall. This damages the speakers or causes personal injury.

Do not install the speakers to a wall with nails, adhesives, or any other unstable hardware.

To avoid accidents resulting from tripping over loose speaker cords, fix them to the wall. Secure installation is the purchaser's responsibility.

## SPEAKER PLACEMENT

This speaker is designed to be used as a main, center, surround or effects speaker

- **Main speaker** placement should be separated by distance of 6-10ft. If they are placed too close together, there will be a reduction in the stereo effect. Conversely. If placed too far apart, the so called "middle-omission" effect will occur and the vocal center fill will be lost. Height of the speaker should be at least at ear level.
- **Center channel speakers** should be placed centered above or below the TV.
- **Surround speakers** should ideally be placed behind the listening area. At least as far apart as the main speakers and up to 2 additional feet apart per side. The height of the speaker should be at a minimum of ear level or preferably somewhat higher.

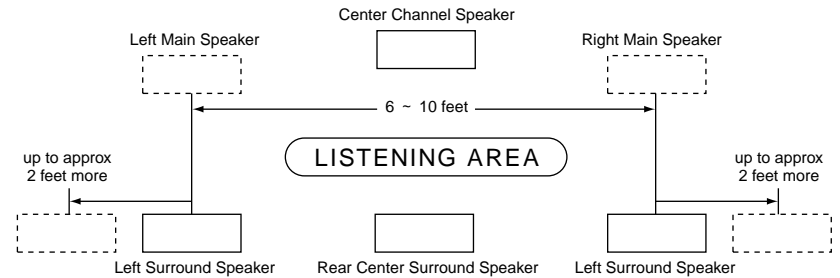

## SPECIFICATIONS

Model	NS-AP3400
Center Speaker	NS-AP3400C
Type	2-way Acoustic Suspension
Speaker: Woofer	Dual 3" Pulp cone and Rubber surround
Speaker: Tweeter	1/2" Balanced dome
Frequency Range	90Hz ~ 50kHz (-10dB)
Impedance	6 ohms
Nominal Input	40w
Maximum Input	120w
Sensitivity (dB/2.83v. 1m)	83dB
Crossover Frequency	2,500Hz
Dimension (H x W x D)	4" x 11 3/8" x 4 3/8" (102 x 290 x 111mm)
Weight	3.37 lbs(1.53kg)
Finish	Silver
Magnetic Shielding	Yes
Main and rear	NS-AP1400S
Type	2-way Acoustic Suspension
Speaker: Woofer	2 3/4" Pulp core and Rubber surround
Speaker: Tweeter	1/2" Balanced dome
Frequency Range	90Hz ~ 50kHz (-10dB)
Impedance	6 ohms
Nominal Input	30w
Maximum Input	100w
Sensitivity (dB/2.83v.In)	80dB
Crossover Frequency	4,000Hz
Dimension (H x W x D)	6 5/8" x 3 5/8" x 4 1/8" (168 x 92 x 106mm)
Weight	1.76 lbs (0.80kg)
Finish	Silver
Magnetic Shielding	Yes
Accessories	120" Bulk Speaker Wire 3/8" x 3/32" Rubber foot 16pcs 1 17/32" x 2" Velcro™ 2pcs

# YAMAHA ELECTRONICS CORPORATION, USA

6660 ORANGETHORPE AVENUE, BUENA PARK, CALIFORNIA 90620 • MAILING ADDRESS: P.O. BOX 6660, BUENA PARK, CALIFORNIA 90622

Yamaha Loudspeakers are designed and manufactured to provide a high level of trouble-free performance. Yamaha Electronics Corporation, USA, is proud of the experienced craftsmanship that goes into each and every Yamaha Loudspeaker. Yamaha sells its Loudspeakers only through a network of high quality, specially authorized dealers and is pleased to offer the following Limited Warranty, which applies only to products purchased from our authorized dealers. We suggest that you read the Limited Warranty thoroughly, and invite you to contact your authorized Yamaha dealer or the Yamaha Electronics Corporation, USA, service department if you have any questions.

## LIMITED WARRANTY NS-AP3400 LOUDSPEAKERS

### Duration of Warranty:

This Speaker System is covered by this warranty for a period of two (2) years beginning from the date of first consumer purchase.

### What is Covered and What is Not Covered?

This warranty covers all defects in materials or workmanship in this product, but DOES NOT COVER the following:

- (1) Damage, deterioration or malfunction resulting from:
  - a. Accident, negligence, misuse, abuse, improper installation or operation or failure to follow instructions contained in your Owner's manual.
  - b. Any shipment of the product. (Claims must be presented to the carrier.)
  - c. Repair or attempted repair by anyone other than Yamaha or an authorized Yamaha Preferred Customer Service Center.
- (2) Any unit which has been altered or on which the serial number has been defaced, modified or removed.
- (3) Normal wear and any periodic maintenance.
- (4) Any unit which has not been purchased from an authorized YAMAHA dealer in the U.S.A. If you are uncertain as to whether a dealer has been authorized by YAMAHA, please contact YAMAHA's Service Department.
- (5) Any unit used for industrial or commercial purposes.

### Who may enforce the warranty:

This warranty is enforceable only by the original purchaser.

### What we will pay for and what you must pay for:

YAMAHA will repair or replace units covered by this warranty, without charge to the consumer for labor or materials. YOU ARE RESPONSIBLE FOR ANY INSTALLATION OR REMOVAL CHARGES AND FOR ANY INITIAL SHIPPING CHARGES. If the Components must be shipped for warranty service. However, we will pay the return shipping charges to any destination within the U.S.A. if the repairs are covered by the warranty.

### How you can get Warranty Service:

- (1) YAMAHA Speaker Systems requiring service must be delivered to any authorized YAMAHA Service Center within the fifty states of the U.S.A., the District of Columbia or Puerto Rico. Warranty service is not available at any other location or outside the U.S.A.
- (2) Units shipped for service should be packed securely and must be accompanied by a detailed explanation of the problem(s) requiring service And Bill of Sale as proof of Warranty coverage.
- (3) Warranty registration is not required for Warranty coverage.

### Limitation of Implied Warranties:

ANY IMPLIED WARRANTIES, INCLUDING WARRANTIES OF MERCHANTABILITY AND FITNESS FOR A PARTICULAR PURPOSE, ARE LIMITED IN DURATION TO THE LENGTH OF THIS WARRANTY.

### Exclusion of Damages

YAMAHA'S LIABILITY, FOR ANY DEFECTIVE PRODUCT, IS LIMITED TO REPAIR OR REPLACEMENT OF THE PRODUCT, AT OUR OPTION. YAMAHA SHALL NOT BE LIABLE FOR INCIDENTAL OR CONSEQUENTIAL DAMAGES OR DAMEGES OF ANY OTHER KIND OR CHARACTER BECAUSE OF PRODUCT DEFECTS.

SOME STATES DO NOT ALLOW LIMITATIONS ON HOW LONG AN IMPLIED WARRANTY LASTS AND/OR DO NOT ALLOW THE EXCLUSION OR LIMITATION OF INCIDENTAL OR CONSEQUENTIAL DAMAGES, SO THE ABOVE LIMITATIONS AND EXCLUSIONS MAY NOT APPLY TO YOU. THIS WARRANTY GIVES YOU SPECIFIC LEGAL RIGHTS, AND YOU MAY ALSO HAVE OTHER RIGHTS WHICH VARY FROM STATE TO STATE.

For the nearest authorized **YAMAHA Preferred Customer** Service Center please call:

**1-800-4-YAMAHA**

Should you have any questions about service received or if you need assistance in locating an authorized Yamaha Service Center, please contact:



**YAMAHA ELECTRONICS CORPORATION, USA**

6660 ORANGETHORPE AVENUE, BUENA PARK, CALIFORNIA 90620-MAILING ADDRESS: P.O. BOX 6660, BUENA PARK, CALIFORNIA 90622

YAMAHA Website Address-<http://www.yamaha.com> Phone: (714) 522-9105

YAMAHA products are backed by a nationwide network of high quality YAMAHA authorized Service Centers, providing prompt, courteous and professional service.